

MIPRO®

ACT-80TC Bodypack Transmitter

(Rechargeable Lithium Battery)

ACT-80T Bodypack Transmitter

(Two AA Disposable Batteries)

User Guide



ACT-80TC



ACT-80T

I. Parts Name, Fig. 1

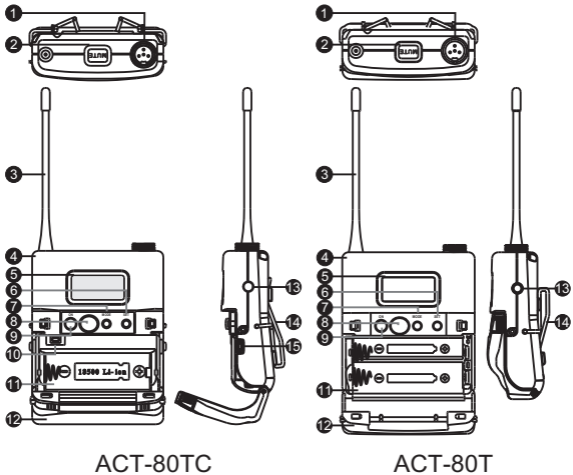

Fig. 1

- ① 4-Pin Microphone Input Jack.
- ② Mute button.
- ③ Transmitting Antenna.
- ④ Housing.
- ⑤ LCD Panel.
- ⑥ SET button.
- ⑦ MODE button.
- ⑧ ACT Sync Window.

- ⑨ Power Switch.
- ⑩ Battery protection circuit reset button.
(Rechargeable)
- ⑪ Battery Compartment.
- ⑫ Battery Cover.
- ⑬ Remote control mute connector.
- ⑭ Reversible Belt Clip, Fig. 2.
- ⑮ Battery Charging Contact. (Rechargeable)

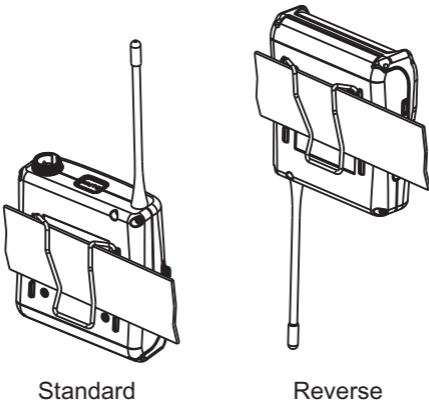

Fig. 2

II. 4-Pin Microphone Input Jack Connection

1. Before turning on the power, connect the input signal source to the microphone input jacket ❶ first to avoid open-circuit induced noise.
2. Align and fasten the connector clockwise for a secured fit, Fig. 3.

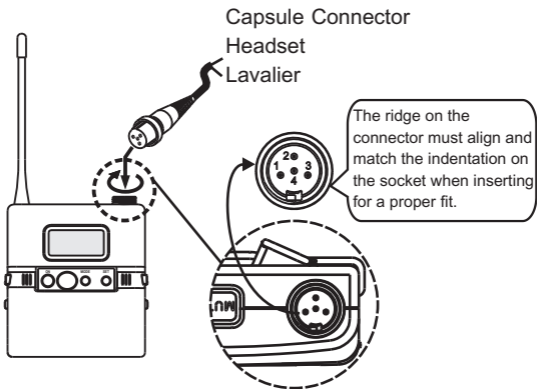

Fig. 3

III. LCD Display, Fig. 4

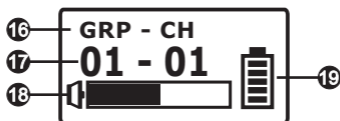

Fig. 4

- ①6 Transmitter Functions.
- ①7 Transmitter Parameters.
- ①8 Audio Signal Meters.
- ①9 Transmitter Battery Display.

IV. Operating Instructions

1. Press MODE button **7** to move the cursor and access the following parameters in Fig. 5.
2. Press SET button **6** to activate parameters for changing. Press SET button during blinking to change a parameter value, Fig. 5.

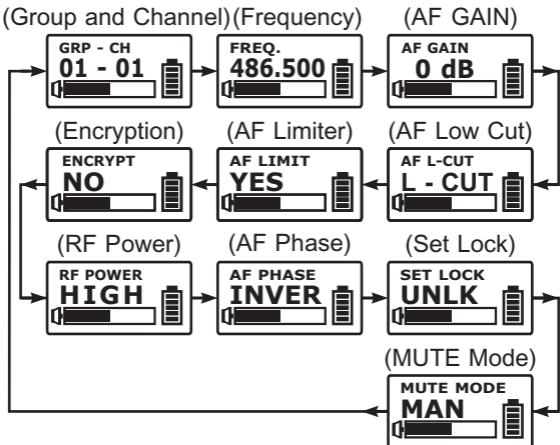
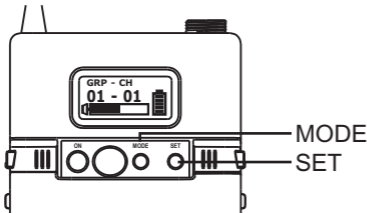

Fig. 5

3. GRP-CH: Display Group and Channel Information, Fig. 6.

- (A) Press MODE button to access GRP-CH to show current group and channel. Blinking will stop after 30 seconds.
- (B) Group and Channel are synced from receiver and cannot be changed, Fig. 6.

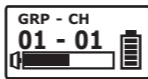

Fig. 6

- (C) To change Group and Channel, do it on the receiver and then press ACT button on the receiver to sync.
- (D) The specific Group and Channel set by PC will display * * * * , Fig. 7.



Fig. 7

4. Frequency: Display Transmitter Frequency Information, Fig. 8.

- (A) Press MODE button to access **FREQ.** to show the current frequency. Blinking will stop after 30 seconds.
- (B) Frequency is synced from receiver and cannot be changed.
- (C) To change frequency, do it on the receiver and then press ACT button on the receiver to sync.

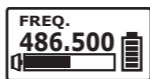

Fig. 8

5. AF GAIN: Setup of Input Sensitivity, Fig. 9.

- (A) AF Gain can be changed from -12dB ~ 18dB, in 6dB steps.
- (B) Press MODE button to access AF GAIN and the parameters start blinking and is ready to be changed.
- (C) Press SET button to change. Every push of the SET button increases the dB value by 6dB to a maximum of 18dB.
- (D) The higher the AF gain is, the lower the dynamic range for input signal will be and it will increase noise and feedback chances.
- (E) Set AF Gain to 0dB for electric guitar. The maximum input signal strength is $2V_{rms}(6dBV)$.

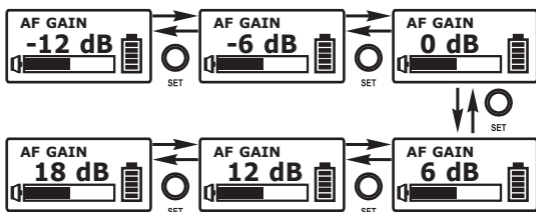

Fig. 9

6. AF L-CUT: Setup of Low Frequency Cut Off, Fig. 10.

- (A) Press MODE button to access AF L-CUT and the parameters start blinking and is ready to be changed.
- (B) Press SET button to set L-CUT or FLAT.
- (C) Press MODE button to save or the parameter saves automatically when blinking stops.
- (D) When the AF L-CUT parameter is L-CUT, the frequency response at 100Hz will decrease about 3dB with a slope of -6dB/Octave.

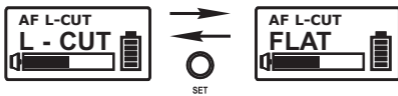

Fig. 10

7. AF LIMIT: Setup of Input Limit, Fig. 11.

- (A) Press MODE button to access AF LIMIT and the parameters start blinking and is ready to be changed.
- (B) Press SET button to set YES or NO.
- (C) Press MODE button to save or the parameter saves automatically when blinking stops.
- (D) When the LIMIT is YES, the maximum output of the receiver is limited to 1V.



Fig. 11

8. ENCRYPTION: Display Encryption Information, Fig. 12.

- (A) Press MODE button to access ENCRYPTION and the parameters start blinking.
- (B) Blinking will stop after 30 seconds.
- (C) The ENCRYPTION function must be set at receiver first then using ACT to program the transmitter. (Refer to ENCRYPTION function of the receiver)



Fig. 12

9. RF POWER: RF Power Selection, Fig. 13.
- (A) Press MODE button to access RF POWER and the parameters start blinking and is ready to be changed.
 - (B) Press SET button to set HIGH or LOW.
 - (C) Press MODE button to save or the parameter saves automatically when blinking stops.
 - (D) HIGH has 50mW transmitting power. LOW has 10mW transmitting power. Set appropriate power to meet region/country regulations.



Fig. 13

10. AF PHASE: Phase Selection of AF inputs,
Fig. 14.

- (A) Press MODE button to access AF PHASE and the parameters start blinking and is ready to be changed.
- (B) Press SET button to set NORM or INVER. NORM is positive polarity; INVER is reverse polarity.
- (C) Press MODE button to save or the parameter saves automatically when blinking stops.
- (D) AF PHASE function provides users a phase selection for different condenser microphones. The normal setting is NORM, and INVER might be selected if two-wire condenser microphone is used.



Fig. 14

11. SET LOCK: Setup of Parameter Lock, Fig. 15.

- (A) Press MODE button to access SET LOCK and the parameters start blinking and is ready to be changed.
- (B) Press SET button to set UNLK or LOCK. UNLK is unlock; LOCK is lock.
- (C) Press MODE button to save or the parameter saves automatically when blinking stops.
- (D) During LOCK mode, receiver settings cannot be changed including the powering on / off. To power off it needs to be in unlock mode (UNLK). A sudden loss of power will deactivate the LOCK function.
- (E) MUTE function can be operated normally during LOCK mode.

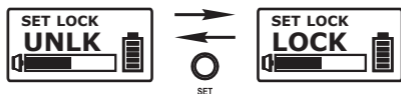

Fig. 15

12. MUTE MODE, Fig. 16.

- (A) Press MODE button to access MUTE MODE and the parameters start blinking and is ready to be changed.
- (B) Press SET button to set MAN, DIS or HOLD.
- (C) Press MODE button to save or the parameter saves automatically when blinking stops.

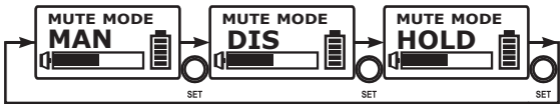

Fig. 16

- (D) MAN: Standard setting where mute function can be controlled by mute button, Fig. 17.
 - (a) Audio is muted when MUTE button is pressed and AF MUTE indicator starts blinking. Press MUTE button again to cancel.
 - (b) AF MUTE cancels automatically when power off.

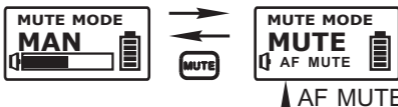

Fig. 17 AF MUTE blinks continuously

- (E) DIS: MUTE button is disabled and mute function is cancelled.

(F) HOLD, Fig. 18.

- (a) Press and hold MUTE button to mute continuously. Release MUTE button to un-mute.
- (b) Under this mode, an optional MJ-70, Remote Mute Switch (not included), can be used to MUTE and un-mute externally.

MUTE ON
audio is muted.

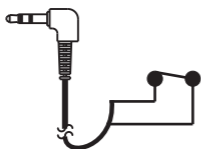

MUTE OFF
audio is on.

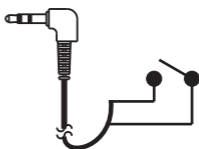

Fig. 18

V. Battery Level Status

Once level falls to 10%, the cursor blinks, ACT-80T needs to be replaced with new batteries and ACT-80TC needs to be charged. Device will power off automatically with an OFF message once power level falls too low, Fig. 19.

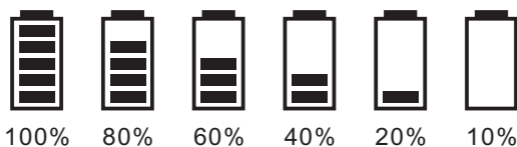

Fig. 19

VI. Power On/Off

1. Press and hold power button for two seconds to power on or power off the device. LCD is lit when power is turned on.
2. The LCD screen display OFF... during powering off, Fig. 20.



Fig. 20

3. Error codes:
 - (A) ROM-ER→ Channel wasn't programmed or internal data error.
 - (B) ERROR1→ Malfunction of the RF frequency circuit.
 - (C) NO----03→ The set frequency exceeds the upper band. The microphone frequency will not be changed but it can be operated as long as the power switch is turned on again.
 - (D) NO----04→ The set frequency exceeds the lower band. The microphone frequency will not be changed but it can be operated as long as the power switch is turned on again.

VII. MUTE Control Set-Up, Fig. 21

1. Press MUTE button to mute audio temporarily. The audio signal meter displays AF MUTE and keeps blinking. Parameter values can be changed and ACT sync activates during this MUTE mode.
2. Press MUTE button to un-mute. AF MUTE cancels automatically when power off.
3. MUTE button works under MAN mode of MUTE MODE.

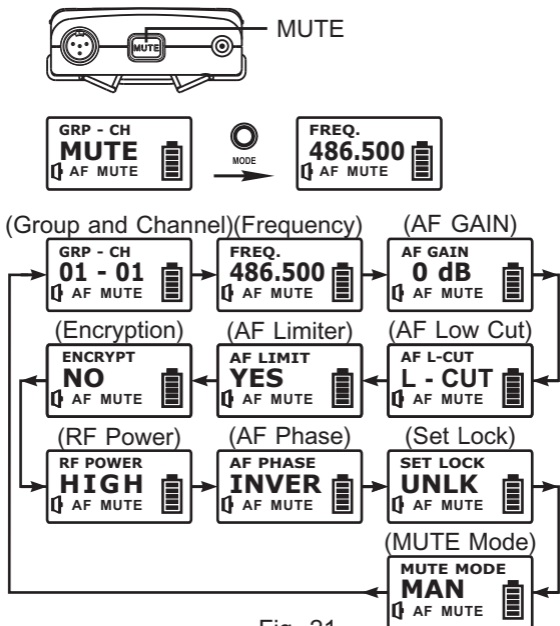

Fig. 21

4. External Mute Connector, Fig. 22.

External mute connector is a 3.5 Ø jack. When an external mute switch cable, MJ-70 (optional) is connected, user can manually mute and unmute the audio temporarily.

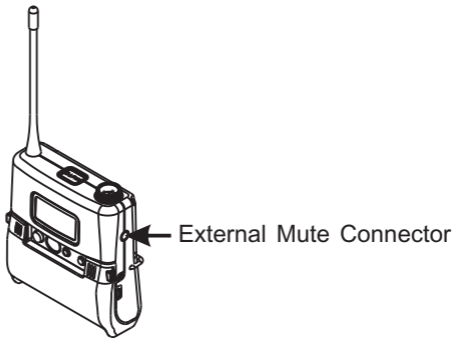

Fig. 22

5. External Mute Switch cable (optional), Fig. 23.

20 External Mute Switch plug.

21 External Mute Switch button.

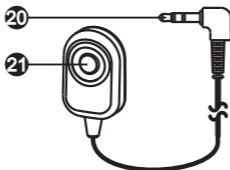

Fig. 23

Caution: Plug MJ-70 into the remote control mute connector 13 before turning on the power.

VIII. High-frequency Noise Interference

High-frequency noise interference produces continuous high-frequency noise, which deteriorates sound quality. All MIPRO microphone capsule modules have high-frequency noise interference prevention design. High-frequency noise interference may occur when other brands' microphone capsules are plugged into MIPRO transmitters.

IX. 4-Pin Microphone Input Jack Wiring, Fig. 24



Fig. 24

1. 2-wire electret condenser microphone capsule connection, Fig. 25.

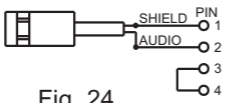

Fig. 24



2. 3-wire electret condenser microphone capsule connection, Fig. 26.

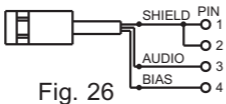

Fig. 26



3. Dynamic Microphone, Fig. 27.

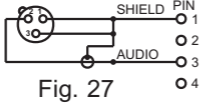

Fig. 27



4. Electric Guitar, Fig. 28.

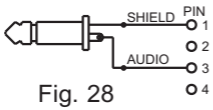

Fig. 28



5. Line-input (impedance 8K ATT 10dB), Fig. 29.

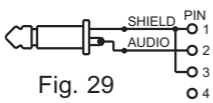

Fig. 29



X. AA Battery Insertion and Replacement

1. Press the side hooks to open battery compartment. Remove the battery carefully, Fig. 30.
2. Insert two AA sized batteries according to correct polarity, Fig. 31.
3. Power off to conserve battery power. Remove the battery when it will not be used for extended periods of time.

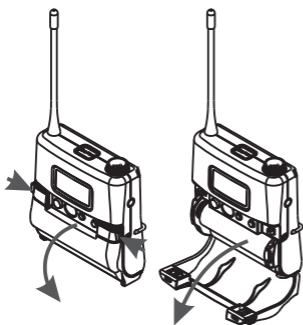

Fig. 30

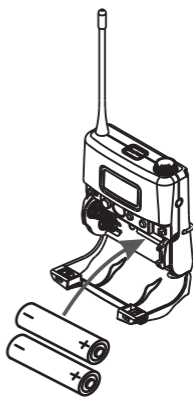

Fig. 31

XI. Rechargeable Battery Insertion and Replacement

1. Press the side hooks to open battery compartment. Remove the battery carefully, Fig. 32.
2. Insert one 18500 type lithium battery according to correct polarity, Fig. 33.

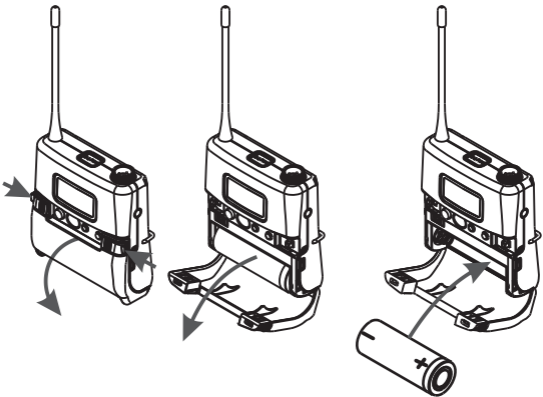

Fig. 32

Fig. 33

3. Check battery polarity was inserted correctly if battery power is sufficient but unable to turn on the transmitter. Battery protection circuit is activated if correct battery polarity. Below methods are available to bypass the battery circuit protection.

- (A) Insert the transmitter into the single or dual-docking battery charger for at least 10 seconds. Power on the transmitter.
- (B) Insert battery with incorrect polarity first. Remove and re-insert again with correct polarity.
- (C) Open battery compartment, press the battery protection circuit button as shown in Fig. 34. Power on the transmitter.

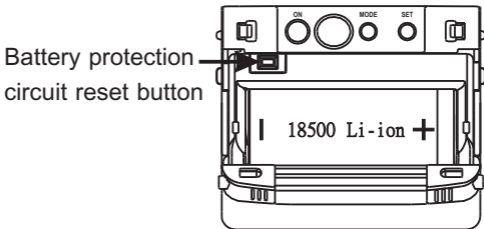

Fig. 34

- (D) Power off to conserve battery power. Remove the battery when it will not be used for extended periods of time.
- (E) We recommend transmitter to be recharged directly in the docking battery charger.

XII. Transmitter Battery Chargers (optional)

1. Transmitter(s) can be inserted into single-docking or dual-docking battery chargers (Fig. 35 & 36) or 18500 rechargeable battery can be recharged in dual-docking battery charger (Fig. 37).
2. MP-8 single-docking battery charger, Fig. 35.

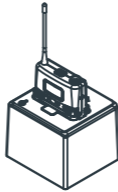

Fig. 35: MP-8: Single-docking Battery Charger.

3. MP-80 dual-docking battery charger, Fig. 36.

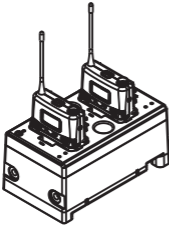

Fig. 36: MP-80:
Dual-docking Battery
Charger.

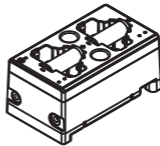

Fig. 37: 18500
rechargeable battery
charging in MP-80.

XIII. Notes

1. Refer to actual product in the event of product description discrepancy.
2. Frequency range and maximum deviation comply with the regulations of different countries.

FCC

FCC Caution: To assure continued compliance, any changes or modifications not expressly approved by the party responsible for compliance could void the user's authority to operate this equipment. (Example - use only shielded interface cables when connecting to computer or peripheral devices).

This device complies with Part 15 of the FCC Rules. Operation is subject to the following two conditions:

- (1) This device may not cause harmful interference, and
- (2) This device must accept any interference received, including interference that may cause undesired operation.

This device complied with FCC radiation exposure limits as set forth for an uncontrolled environment. This device should be installed and operated so that its antenna(s) are not co-located or operating in conjunction with any other antenna or transmitter.

IC

This device complies with Industry Canada's RSSs. Operation is subject to the following two conditions:

- (1) This device may not cause interference; and
- (2) This device must accept any interference, including interference that may cause undesired operation of the device.

Le présent appareil est conforme aux CNR d'Industrie Canada applicables aux appareils radio. L'exploitation est autorisée aux deux conditions suivantes:

- (1) l'appareil ne doit pas produire de brouillage;
- (2) l'utilisateur de l'appareil doit accepter tout brouillage radioélectrique subi, même si le brouillage est susceptible d'en compromettre le fonctionnement.

MIPRO[®]
MICROPHONE PROFESSIONALS

All rights reserved. MN 018/08

Do not copy or forward without prior approvals MIPRO.

Specifications and design subject to change without notice.

MIPRO Electronics Co., Ltd

Headquarters : 814 Pei-Kang Road, Chiayi,60096,Taiwan

Tel : +886.5.238.0809

www.mipro.com.tw

Fax : +886.5.238.0803

mipro@mipro.com.tw



2CE625A